

# Original operating instructions

Combined refrigerator-freezer

Read the operating instructions before switching on for the first time

Page 10

EN

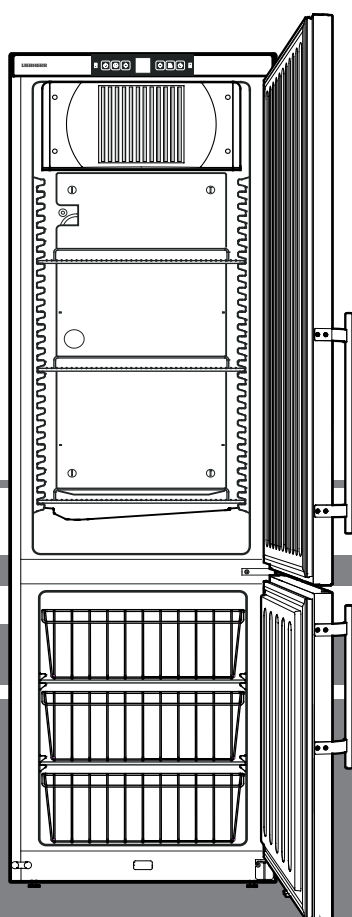

GCv 4010

GCv 4060

**7083 168-00**

GCv

**LIEBHERR**

## Content

Priority of warnings.....	10
EPREL database.....	10
Safety instructions and warnings.....	10
Symbols on the appliance.....	11
Intended use.....	11
Foreseeable incorrect use.....	11
Declaration of conformity.....	11
Climate rating.....	11
Noise emissions from the appliance.....	11
Description of the appliance.....	12
Setting up.....	12
Levelling the appliance.....	12
Appliance dimensions.....	12
Electrical connection.....	12
Safety lock.....	12
Operating and control elements.....	12
Switching the appliance on and off.....	13
Setting the temperature.....	13
Door open alarm.....	13
Temperature alarm.....	13
Humidity function.....	13
Setup mode.....	14
Cooling.....	14
Defrosting.....	15
Cleaning.....	15
Shutting your appliance down.....	15
Malfunctions.....	15
Disposal notes.....	15
Changing over door hinges.....	16

## Priority of warnings

<b>⚠ DANGER</b>	identifies a situation involving direct danger which, if not obviated, may result in death or severe bodily injury.
<b>⚠ WARNING</b>	identifies a dangerous situation which, if not obviated, may result in death or severe bodily injury.
<b>⚠ CAUTION</b>	identifies a dangerous situation which, if not obviated, may result in minor or medium bodily injury.
<b>NOTICE</b>	identifies a dangerous situation which, if not obviated, may result in damage to property.
<b>Note</b>	identifies useful information and tips.

## EPREL database

As from 1 March 2021, information about energy labelling and ecodesign requirements will be available in the European product database (EPREL). You can access the product database using the following link: <https://eprel.ec.europa.eu/>. You will be asked to enter the model identifier. You will find the model identifier on the type plate.

## Safety instructions and warnings

- **WARNING:** do not seal ventilation openings on the appliance housing or enclosure. →

- **WARNING:** only use the mechanical devices or other aids recommended by the manufacturer to help speed up the defrosting process.

- **WARNING:** do not damage the refrigerant circuit.

- **WARNING:** do not use any electrical devices in the refrigerator compartment which do not comply with the design recommended by the manufacturer.

- **WARNING:** the mains cable must not be damaged while installing the appliance.

- **WARNING:** multi-sockets or distributor strips and other electronic devices (such as halogen transformers) must not be positioned and operated at the rear of appliances.

- **WARNING:** this appliance must be secured as described in the operating instructions to rule out any potential risks due to its instability.

- This appliance can be used by children of 8 years old and over, and also by persons with restricted physical, sensory or mental capacity or lack of experience and knowledge, if they are supervised or have been instructed on safe use of the appliance and understand the resulting risks. Children must not be allowed to play with the appliance. Cleaning and user maintenance must not be carried out by children without supervision.

- To prevent injury and damage to property, the appliance should only be installed by two people.

- After unpacking it, check the appliance for signs of damage. Contact the supplier if it is damaged. Do not connect the appliance to the mains power supply.

- Avoid prolonged skin contact with cold surfaces (e.g. chilled/frozen products). If necessary, take safety action (e.g. gloves).

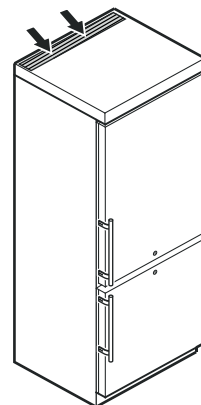

- All repairs and work on the appliance may only be carried out by customer service personnel or other trained personnel. The same applies to changing the mains power cable.

- Only carry out repair and other work on the appliance when the mains plug has visibly been disconnected.



- Only install, connect and dispose of the appliance as described in these operating instructions.
- In the event of a fault, pull out the plug or switch off the fuse.
- When disconnecting the appliance from the mains, pull on the plug. Do not pull on the cable.
- Do not allow naked flames or ignition sources to enter the appliance.

## Symbols on the appliance

	The symbol can be located on the compressor. It refers to the oil in the compressor and indicates the following danger: swallowing or inhaling can be fatal. This is only relevant for recycling. There is no danger in normal operation.
	Warning about inflammable substances.
	A sticker to this effect may be applied to the rear of the appliance. It refers to the foampadded panels in the door and/or the housing. This is only relevant for recycling. Do not remove the sticker.

## Intended use

The appliance is suited only for cooling food.

This appliance may be used to display food and drink in retail sales outlets. It is suitable for commercial use, for example in restaurants, canteens, hospitals and in commercial businesses such as bakeries, butchers' shops, supermarkets, etc.

This professional refrigeration appliance is designed for storing chilled food (refrigerator compartment).

This professional refrigeration appliance is designed for storing frozen food (freezer compartment).

It is **not** designed for the presentation of food or for the removal of food by customers.

The appliance is designed for use in enclosed rooms. All other types of use are not permitted.

## Foreseeable incorrect use

**Do not use** the appliance for the following applications:

- Storage and cooling of medicines, blood plasma, laboratory preparations or similar substances and products subject to the Medical Devices Directive 2007/47/EC.
- Use in potentially explosive atmospheres.
- Use outdoors or in areas where it is exposed to splash water or damp conditions.





Incorrect use of the appliance will result in damaging or spoiling the goods stored in it.

## Declaration of conformity

The refrigerant circuit has been tested for leaks. The appliance complies with the relevant safety regulations and EU Directives 2006/42/EG, 2014/30/EU, 2009/125/EG and 2011/65/EU.

## Climate rating

The climate rating indicates at what room temperature the appliance may be operated to achieve full cooling capacity and what the maximum humidity level in the area around the appliance may be to ensure that no condensation forms on the exterior housing.

<b>LIEBHERR</b>		XXXX 9999 Index Service-Nr./No. Service		Klasse/Class Classe/Clase			
							
Refrigerant	Gas	R134a	R134a	R134a	R134a	R134a	R134a
Net Capacity	Net	10	12	12	12	12	12
Max. room Temp.	Max.	10	12	12	12	12	12
Max. rel. Hum.	Max.	10	12	12	12	12	12
Capacity	Capacity	10	12	12	12	12	12
Serial No.	Serial No.	99.999.999.9	99.999.999.9	99.999.999.9	99.999.999.9	99.999.999.9	99.999.999.9

The climate rating is indicated on the type plate.

Climate rating	Max. room temperature	Max. relative humidity
3	25 °C	60%
4	30 °C	55%
5	40 °C	40%
7	35 °C	75%

The minimum room temperature at the place of installation is 10°C.

## Noise emissions from the appliance

The noise level while the appliance is operating is below 70 dB(A) (relative noise level 1 pW).

## Description of the appliance

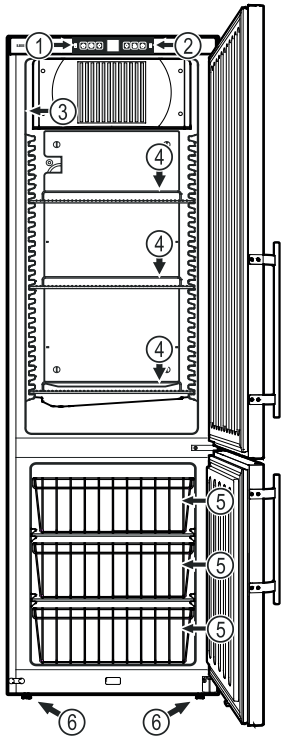

- (1) Operating and control elements (refrigerator)
- (2) Operating and control elements (freezer)
- (3) Type plate
- (4) Grid shelves
- (5) Baskets
- (6) Adjustable-height feet

### NOTICE

The maximum load per grid shelf is 45 kg.

The maximum load per basket is 20 kg.

## Setting up

- Do not place the appliance in direct sunlight or near radiators and similar sources of heat.
- The more coolant there is in the appliance, the larger the room in which the appliance is installed must be. If the room is too small, any leak may create a flammable mixture of gas and air. For each 8 g of coolant the installation space must be at least 1 m<sup>3</sup>. Information on the coolant is on the model plate inside the appliance.
- Always install the appliance directly against the wall.

## Levelling the appliance

Compensate floor unevenness using the adjustable feet.

### NOTICE

The appliance must be aligned horizontally and vertically. If the appliance is not level, the main body of the appliance can be deformed and the door will not close properly.

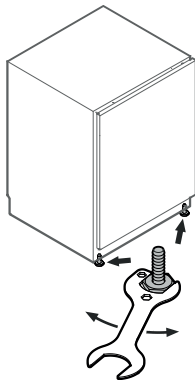

## Appliance dimensions

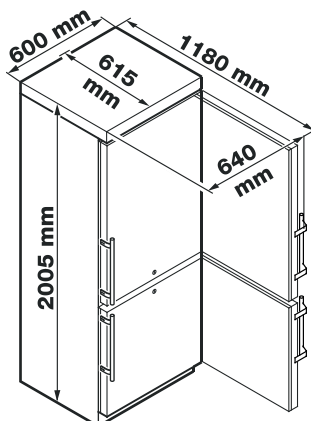

## Electrical connection

Only operate the appliance with **alternating current (AC)**.

The permissible voltage and frequency are indicated on the type plate. The position of the type plate is shown in the section entitled **Description of the appliance**.

The socket must be properly earthed and protected by a fuse. The tripping current of the fuse must be between 10 A and 16 A.

The socket must not be situated behind the appliance and must be easily accessible.

Do not connect the appliance using an extension cable or extension socket.

Do not use stand-alone inverters (conversion of direct current to alternating current/three-phase current) or energy-saving plugs. Risk of damage to the electronic control system!

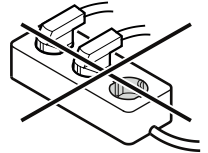

## Safety lock

The lock in the appliance door is equipped with a safety mechanism.

### Locking the appliance

- Insert the key as shown by arrow 1.
- Turn the key 90°.

To unlock the appliance, the same procedure must be repeated in the same order.

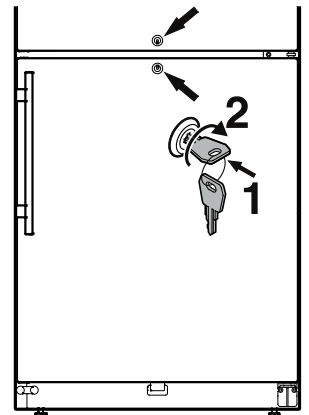

## Operating and control elements

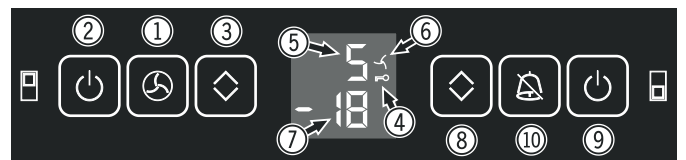

- ① Fan button
- ② On/Off button (refrigerator compartment)
- ③ Temperature setting buttons (refrigerator compartment)
- ④ Keypad lock activated symbol
- ⑤ Temperature display (refrigerator compartment)
- ⑥ Fan On symbol
- ⑦ Temperature display (freezer compartment)
- ⑧ Temperature setting buttons (freezer compartment)
- ⑨ On/Off button (freezer compartment)
- ⑩ Mute alarm

## Switching the appliance on and off

Clean the interior of the appliance before switching it on for the first time (see "**Cleaning**").

### Switching on

Press the On/Off button ② to switch on the refrigerator compartment.

Press the On/Off button ⑨ to switch on the freezer compartment.

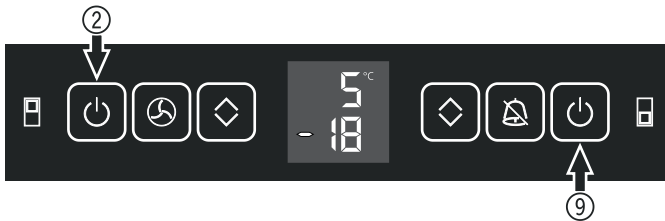

### Switching off

Press the On/Off buttons for approx. two seconds.

## Setting the temperature

The temperature of the refrigerator and freezer compartment can be set separately.

### Setting the refrigerator temperature

Press the Up/Down buttons ③.

### Setting the freezer temperature

Press the Up/Down buttons ⑧.

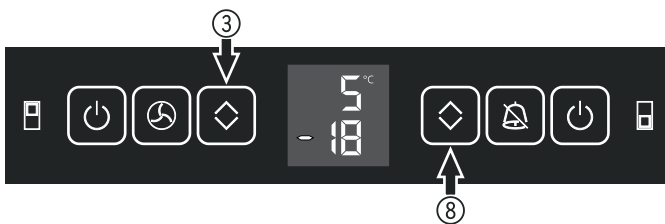

- When pressing one of the buttons for the first time, the display will start to flash.

- Pressing this button again enables you to change the temperature setting.

Keep pressing the **Up/Down** button until the desired value is displayed.

- The electronic control system will switch over automatically about 5 seconds after the last time you pressed the button, and the actual temperature will be displayed.

### Adjustable temperature ranges

**Refrigerator compartment:** +1°C to +15°C

#### Note

The highest adjustable interior temperature of +15°C cannot be achieved if the ambient temperature is +10°C.

**Freezer compartment:** -14°C to -28°C.

#### Note

The temperature in the warmest area of the interior may be higher than the temperature setting.

If the door is left open for a lengthy period, the temperature in the appliance's compartments may rise dramatically.

## Door open alarm

If an appliance door is left open for more than 180 seconds, the audible warning signal will sound.

If the door must be opened for a lengthy period to place items into the appliance, cancel the audible warning signal by pressing the **Alarm** button.



The alarm switches back to standby when the door is shut.

## Temperature alarm

If the temperatures in the interior are out of the permitted range, the audible warning signal will sound and the temperature display will flash.

After a lengthy power failure, the temperature in the interior may have risen to too high a level. After the power supply returns, the fall in temperature can be watched on the display.

- Cancel the audible warning signal by pressing the **Alarm** button.

The temperature display will stop flashing as soon as the temperature in the interior has reached the set value.

### Temperature alarm after a fault in the appliance

If the appliance develops a fault, the temperature in the interior may rise too high or fall too low. The audible warning signal will sound and the temperature display will flash.

If the temperature displayed is too high (warm), first check whether the door is closed correctly.

If the temperature display continues to show a value that is too high or too low after one hour, contact the customer service department.

- Cancel the audible warning signal by pressing the **Alarm** button.

## Humidity function

Certain foods must be stored in a humid atmosphere (e.g. baked goods). To prevent such foods from drying out, the humidity function must be activated.

### Switching on

Press the **Ventilation** button ①. The LED ⑥ will come on.

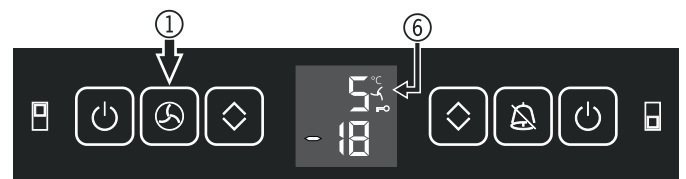

### Switching off



Press the **Ventilation** button ①. The LED ⑥ goes dark.



## Setup mode



### Keypad lock

The keypad lock ensures that no unintentional changes are made to the electronic control system.

### Activating the keypad lock



Press  for 5 seconds. Display = 



Press  Display = 



Press  Display = 

Exit setup mode by pressing the  button (freezer compartment).

### Deactivating the keypad lock



Press  for 5 seconds. Display = 



Press  Display = 



Press  Display = 

Exit setup mode by pressing the  button (freezer compartment).

### Adjusting the display brightness



Press  for 5 seconds. Display = 

Press  Display = 

Press  Display = 

Adjust to the desired brightness using the **Up/Down** button.

**h0** = minimum brightness  
**h5** = maximum brightness

Press  Display = 

Exit setup mode by pressing the  button (freezer compartment).

The adjusted brightness will be activated after one minute.

### Note

If a button is pressed, the display lights up for one minute at maximum brightness.

When commissioning the appliance, the adjusted brightness will only be active once the set interior temperature of the appliance has been reached.

## Cooling

The grid shelves can be moved to accommodate different height bottles or packages.

The ventilation slots on the inside must not be covered!

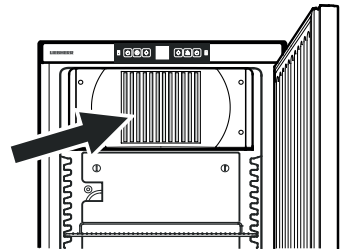

### NOTICE

Store raw meat or fish in clean sealed containers on the bottom shelf of the refrigerator/freezer compartment so that it cannot come into contact with any other food or drip liquid onto it.

A failure to follow these instructions may result in the food being spoiled.

## Defrosting

### Refrigerator compartment

The refrigerator compartment defrosts automatically.

### Freezer compartment

After the appliance has been in operation for some time, a layer of frost or ice will form on the inside walls. This increases energy consumption. You should therefore defrost the appliance regularly.

- To defrost, switch the appliance off.
- Remove the drawers.
- Transfer items to other appliances.
- Leave the door of the appliance open while defrosting. After defrosting, mop up the remaining water with a cloth and clean the appliance.

## Cleaning

### ⚠ WARNING

Before cleaning, always disconnect the appliance from the mains. Pull out the plug or switch off the fuse.

Surfaces which may come into contact with food and accessible drain systems must be cleaned at regular intervals.

- Clean the inside, equipment parts and outer walls with lukewarm water and a little detergent. Do not use chemical solvents or any cleaning agents containing sand or acid.

### ⚠ CAUTION

Risk of damage to the appliance components and risk of injury due to hot steam.

Do not use steam cleaning equipment to clean the appliance.

- Ensure that no cleaning water penetrates into the electrical components or ventilation grille.
- Dry all parts well with a cloth.
- The dust should be removed from the refrigeration unit and heat exchanger - metal grid at the back of the appliance - once a year.
- Do not damage or remove the type plate on the inside of the appliance. It is very important for servicing purposes.
- Clean the drain hole in the refrigerator compartment with a thin object, e.g. cotton swab or the like.

## Shutting your appliance down

If the appliance is left empty for a lengthy period, it must be switched off, defrosted, cleaned and dried and the door is to be left open to prevent mould formation.

## Malfunctions

- **F1, F2 or F3 appears in the display.**

– The appliance has suffered a fault. Contact the customer service department.

**You may be able to rectify the following faults by checking the possible causes yourself:**

- **Appliance does not function:**

- Is the appliance switched on?
- Is the plug correctly fitted in the mains socket?
- Is the fuse intact?

- **When inserting the mains plug, the refrigeration unit does not switch on, but a value is shown in the temperature display.**

– Demo mode is activated.  
Contact the customer service department.

- **The temperature is not low enough:**

- Is the temperature setting correct (see "Setting the temperature")?
- Does the separately installed thermometer show the correct reading?
- Is the ventilation system working properly?
- Is the appliance set up too close to a heat source?

If none of the above causes apply and you cannot rectify the fault yourself, contact the nearest customer service department stating the type designation ①, service number ② and appliance number ③ as indicated on the type plate.

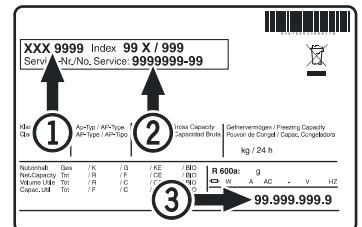

The position of the type plate is shown in the section entitled **Description of the appliance**.

## Disposal notes

The appliance contains reusable materials and should be disposed of properly - not simply with unsorted household refuse. Appliances which are no longer needed must be disposed of in a professional and appropriate way, in accordance with the current local regulations and laws.



Do not damage the refrigerant circuit of an appliance that is no longer needed during its disposal.

This appliance contains inflammable gases in the refrigerant circuit and insulation foam.

Your local council or a waste disposal contractor can provide information about how to dispose of the appliance correctly.



## Changing over door hinges

1. Unscrew the lower hinge bracket.

**Important:** the door mounting has a spring mechanism enabling the door to close by itself. The hinge bracket turns to the left when the screws are undone.

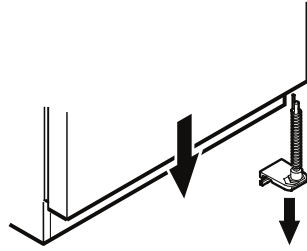

2. Remove the freezer door downwards.

3. Transfer pin on hinge bracket to the opposite side.

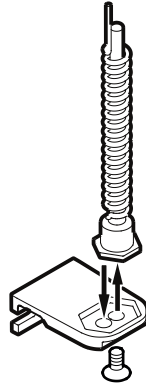

4. Unscrew the pin on the middle hinge bracket.

5. Pull the refrigerator door to the front and remove it downwards.

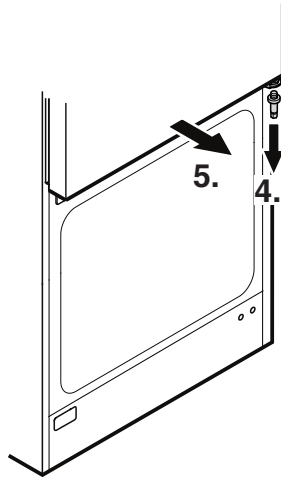

6. Unscrew the middle hinge bracket.

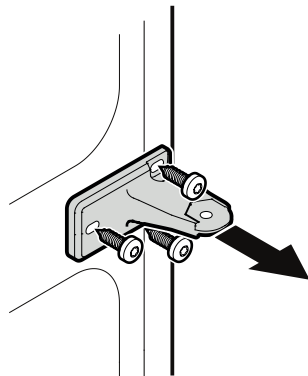

7. Transfer upper hinge components to the opposite side.

8. Transfer the middle cover plate to the opposite side.

9. Transfer the lower cover plate to the opposite side.

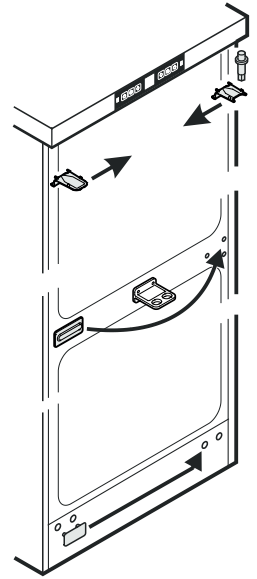

10. Reinstall the middle hinge bracket on the left-hand side.

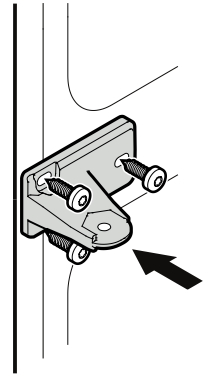

11. Pull out the spring mechanism from the refrigerator door and transfer to the opposite side.

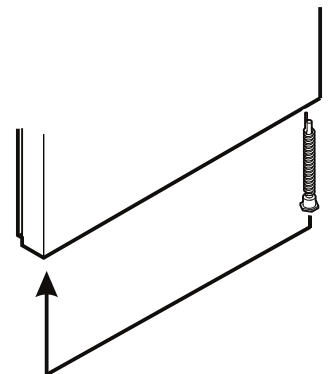



12. Suspend the refrigerator door on the hinge pin and close.

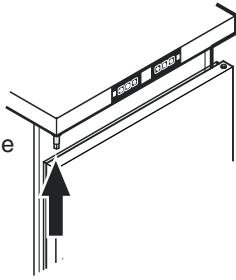

13. Turn the refrigerator door spring mechanism anticlockwise using the open-ended spanner provided, until the hexagon engages in the recess of the middle hinge bracket.

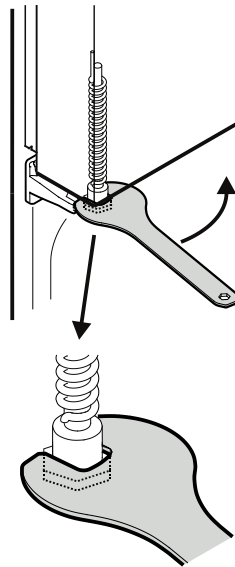

14. Screw the hinge pin into the middle hinge bracket.

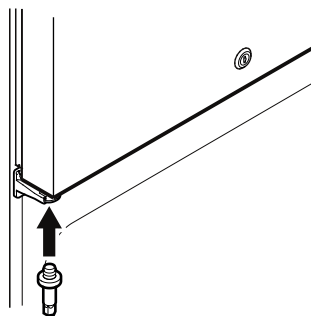

15. Suspend the freezer door on the hinge pin and close.

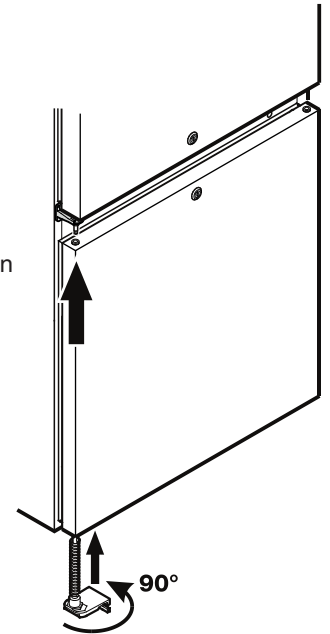

16. Install the lower hinge bracket.

17. Turn hinge bracket by 90° - spring is compressed. Screw on hinge bracket.

18. Transfer the handle and plugs of both doors to the opposite side.

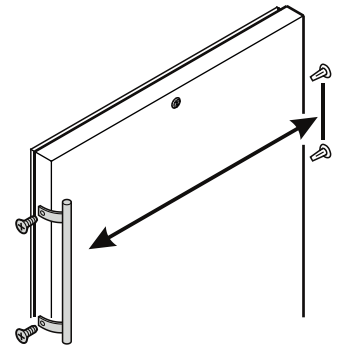



**Liebherr Hausgeräte Lienz GmbH**

Dr.-Hans-Liebherr-Strasse 1

A-9900 Lienz

Österreich

[www.liebherr.com](http://www.liebherr.com)

